

## Prediction of Water Level Fluctuations of Chahnimeh Reservoirs in Zabol Using ANN, ANFIS and Cuckoo Optimization Algorithm

Jamshid Piri<sup>1</sup>, Mohammad Reza Rezaei Kahkha<sup>\*2</sup>

1) Department of Soil & Water, Faculty of Irrigation and Drainage, University of Zabol, Iran

2) Department of environmental health engineering, Zabol University of Medical Sciences, Zabol, Iran

\*Author for Correspondence: m.r.rezaei.k@gmail.com

Received: 1 June 2016, Revised 20 Oct. 2016, Accepted: 1 Dec. 2016

### ABSTRACT

Forecasting changes in level of the reservoir are important in Construction, design and estimate the volume of reservoirs and also in managing of supplying water. In this study, we have used different models such as Artificial Neural Network (ANN), Adaptive Neuro Fuzzy Inference System (ANFIS) and Cuckoo Optimization Algorithm (COA) for forecasting fluctuations in water level of Chahnimeh reservoirs in south-east of Iran. For this purpose, we applied three most important variables in water levels of the reservoir including evaporation, wind speed and daily temperature average to prepare the best entering variables for models. In addition, none accuracy of error in estimation of hydrologic variables and none assurance of exiting models are the result of their sensitivity to the educational complex for teaching of models and also preliminary decoration before beginning general education has been estimated. After comparing exiting and confidence interval of the ANN and ANFIS has been found that the result of ANFIS model is better described than other model because it was more accurate and does have lesser assurance.

**Key words:** Forecasting; Water Level; Chahnimeh; Adaptive Neuro Fuzzy Inference System; Artificial Neural Network; Cuckoo Optimization Algorithm; Optimization

### INTRODUCTION

Behavior modeling of water level fluctuation in lake and reservoir is required for planning and designing hydraulic structure in beaches. Unnatural changes in surface level are due to changes in complicated factors and interaction in which is influential on lake water budget and reservoir. In many researches, researcher has estimated water level by the aid of water equilibrium level in which these changes are related to lake level and reservoir and basic section of water equilibrium.

Forecasting of water levels in reservoirs in different time series by using the past recorded data are an important problem in planning a water reservoir. Changes in their level are the result of so many environmental factors like raining, direct and indirect flood water of adjoining aquifers, free water evaporation, climate temperature and interaction among lakes, reservoir and low level eras [1-3].

Adaptive Neuro Fuzzy Inference System (ANFIS) recognized collection of parameters through learning composite rule including gradient fall error inverted spreading and square quantity error method. Chang and Chang [3] have applied fuzzy-nerve methods for forecasting water level in resource. Chang and Chen [4] has applied one method of modeling fuzzy neuro-

network of none inverted spreading for forecasting real-time of lake flow.

Hong and White [6] have introduced a local system of neuro- fuzzy for modeling complicated water recognition models. Kazeminezhad and *et al.*[8] have applied for ANFIS for forecasting wave parameters in Ontario Lake and has found ANFIS is better than manual beach engineering. Keskin and *et al.* [9] has used of fuzzy models for assessment lake evaporation in the west of Turkey.

Moghadamnia [10] has determined ANFIS method capability for improving daily evaporation precision. The aim purpose of this study is providing a way to study and simulation of daily balance fluctuations of Chahnimeh reservoirs using artificial intelligence methods.

### MATERIALS AND METHODS

#### *Applied data*

We have used of recorded data of water level of Chahnimeh reservoirs in this study. Related information of selected stations was obtained from Sistan and Balouchestan local water organization. Chahnimeh stations are along with Zabol Chahnimeh reservoirs 30° 40' of 30° 50' north and geographical latitude of 61° 40' to 61° 49' in the East in which has

shown in Fig. 1. Location of Chahnimeh reservoirs is characterized with numbers of 1 to 4.

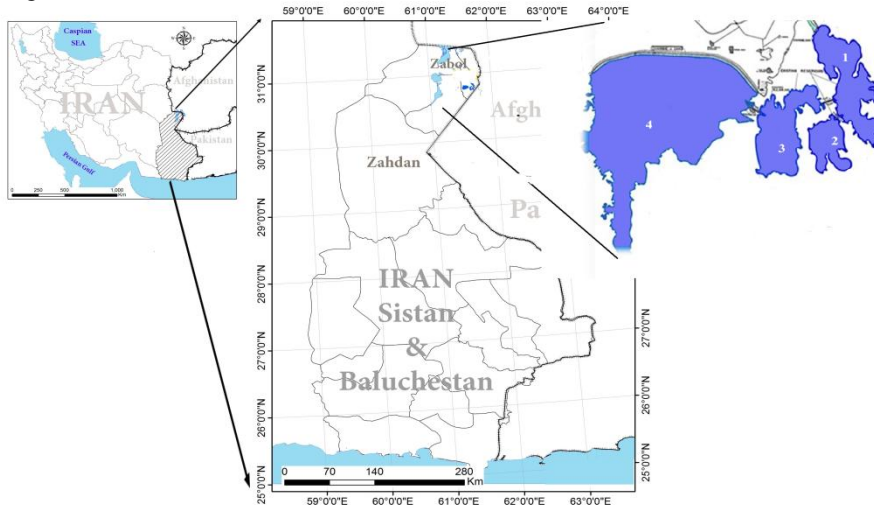

Fig. 1: Sistan plain and location of the Chahnimeh reservoirs

Data samples included daily water level of reservoirs in 4 years (2007-2011) for any model was selected and applied. We have used for the first three years information (1095 daily levels) and the next year

information (daily level 265) for education and testing of models, respectively. Table. 1 shows statistical parameters of applied data on the studied times.

Table1: The statistic parameters of applied data Chahnimeh stations

Station	Data set	Unit	X <sub>mean</sub>	S <sub>x</sub>	C <sub>v</sub>	X <sub>min</sub>	X <sub>max</sub>	Correlation
					(S <sub>x</sub> /X <sub>mean</sub> )			With Level
Chahnimeh	T	°C	23.2	10.2	0,74	-3.9	40.3	0.64
	Ud	km/day	12.5	6.4	0.51	0	32	0.55
	Ea	mm/day	12.4	9.2	0,49	0	35	0.4
	Level	mm	488.6	1.9	0.004	484.83	492.5	1

In this table X<sub>mean</sub>, S<sub>x</sub>, C<sub>v</sub>, X<sub>max</sub> and X<sub>min</sub> are the mean, standard deviation, change constantly, data maximum and minimum. Partial moisture almost is more than 40%. Temperature is the most important factor that influenced the water level. In this investigation more than 70% of recorded temperature was 27° C. Correlation coefficients of this parameter are 0.64 by water level equilibrium. After temperature parameter, evaporation from basin and wind speed has had the most effect on water level equilibrium in which its correlation coefficient is 0.55 and 0.4, respectively.

**Artificial Neural Network**

The ANN is an evolving technique and progresses still being made with this technique. It includes two or three neuron layers to process nonlinear signals.

Entering layer has accepted entering information in which has been processed by hidden layers. On learning duration, middle joining weight and nerves bays has been adjusted repeatedly to reach the error to the least. In a recent study, we have used of perused network layer by one sigmoid transmission function in the hidden layer and linear transmission function in exit layers.

**Adaptive Neuro-Fuzzy Inference System (ANFIS)**

ANFIS have had different application in different eras. ANFIS is five-layers model in which has been introduced by combining fuzzy rational model and artificial neuro-system (Fig. 2).

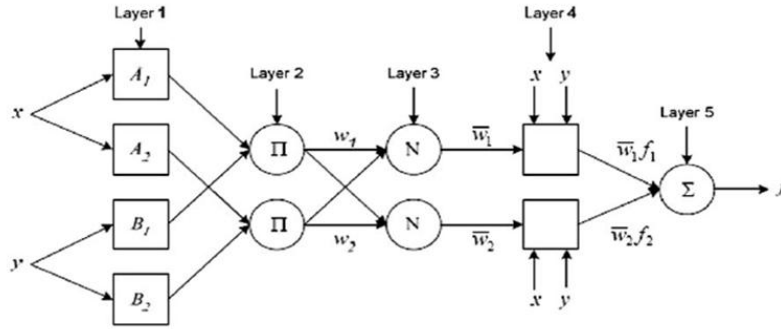

Fig. 2: The structure of an ANFIS net

**Result evaluation**

For comparison of simulation result and forecasted by artificial intelligence and statistic models, we have used of error square mean root and error deviation mean measures.

$$RMSE = \sqrt{\frac{\sum_{i=1}^n (Z^0(x_i) - Z(x_i))^2}{n}} \quad (1)$$

$$MAE = \frac{\sum_{i=1}^n (Z^0(x_i) - Z(x_i))}{n} \quad (2)$$

$$R^2 = 1 - \frac{\sum_{i=1}^n (Z^0(x_i) - Z(x_i))^2}{\sum_{i=1}^n (Z(x_i) - \bar{Z}(x_i))^2} \quad (3)$$

N is the number of points,  $Z^0(x_i)$  estimated amount,  $Z(x_i)$  and real amount of z variable in  $x_i$  point.

**Cuckoo Optimization Algorithm (COA)**

The naming of Cuckoo Optimization Algorithm (COA) model is inspired from a bird family, called Cuckoo. The basic steps of the COA can be summarized as the pseudo code, as follows (Fig. 3) When producing new solutions  $x_i(t+1)$  for the  $i^{th}$  cuckoo, the following Levy flight is applied

$$X_i(t+1) = X_i(t) + \alpha \oplus Levy(\lambda), \quad (4)$$

Where  $\alpha > 0$  is the step size. The product  $\oplus$  expressed entry-wise multiplications [11-13]. In this study, a Levy flight that distributed according to the following probability distribution was applied.

$$Levy\ u = t^{-\lambda}, \quad 1 < \lambda \leq 3 \quad (5)$$

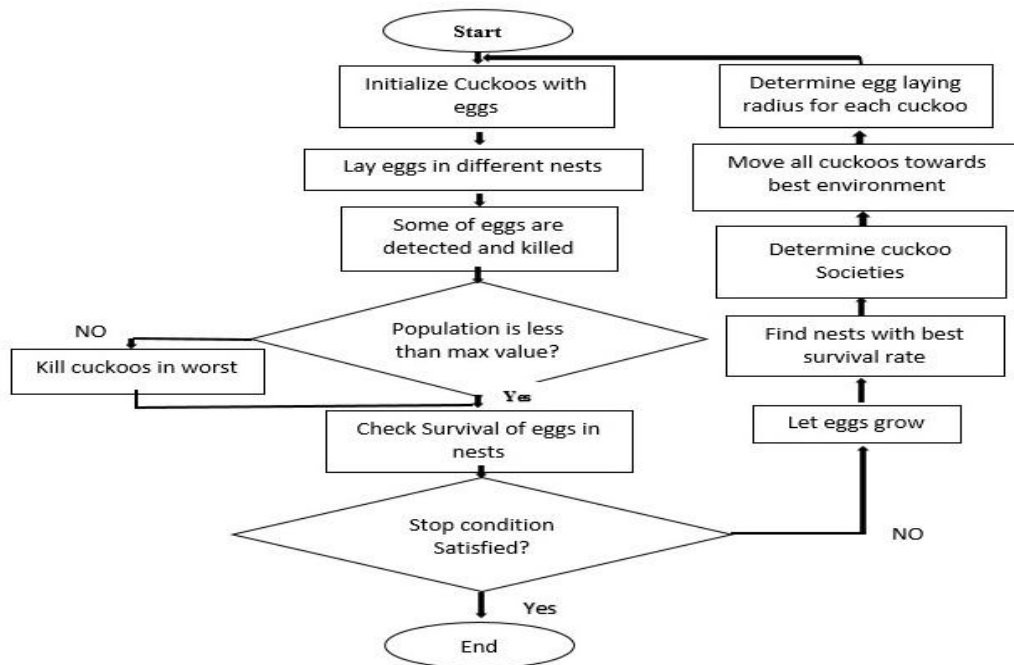

Fig.3: Flowchart of cuckoo optimization algorithm

**RESULTS**

*ANN models*

The object of this study is providing 1, 2 and 3-day for forecasting of water level of reservoir’s fluctuation by ANN (Fig.4) and ANFIS models (Fig 5). Data correlation has been applied for selecting accurate entering vector. Auto-correlation and part self-correlation statistic and confidence yields 95%

has been estimated from 0 to 10 delays for time series of daily reservoir level.

By considering correlation analysis, entering data composition would be evaluated (Table 2):

- (i)  $L_i$
- (ii)  $L_{i-1}$  and  $L_i$
- (iii)  $L_{i-2}, L_{i-1}$  and  $L_i$

**Table 2:** Validation statistics of ANN models.

Model inputs	ANN structure (input–hidden–output)	R <sup>2</sup>	RMSE(m)	MAE(m)
<b>+1day prediction</b>				
$L_i$	1-4-1	0.989	0.078	0.046
$L_{i-1}, L_i$	2-8-1	0.988	0.06	0.038
$L_{i-2}, L_{i-1}, L_i$	3-9-1	0.991	0.055	0.033
<b>+2day prediction</b>				
$L_i$	1-3-1	0.988	0.078	0.046
$L_{i-1}, L_i$	2-8-1	0.980	0.083	0.061
$L_{i-2}, L_{i-1}, L_i$	3-4-1	0.983	0.080	0.058
<b>+3day prediction</b>				
$L_i$	1-4-1	0.973	0.13	0.08
$L_{i-1}, L_i$	2-9-1	0.977	0.095	0.073
$L_{i-2}, L_{i-1}, L_i$	3-4-1	0.978	0.089	0.070

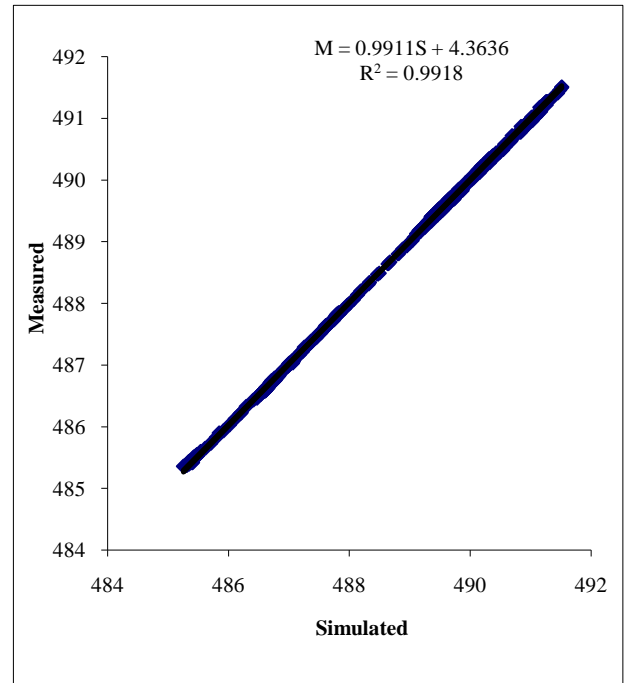
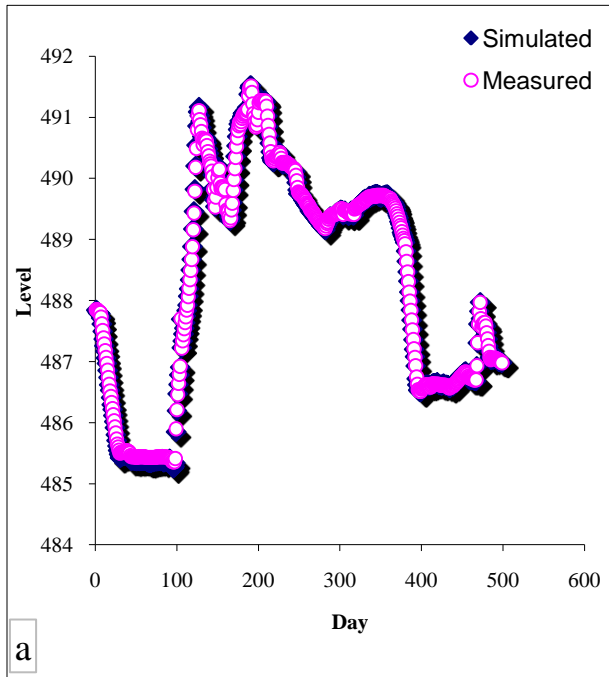

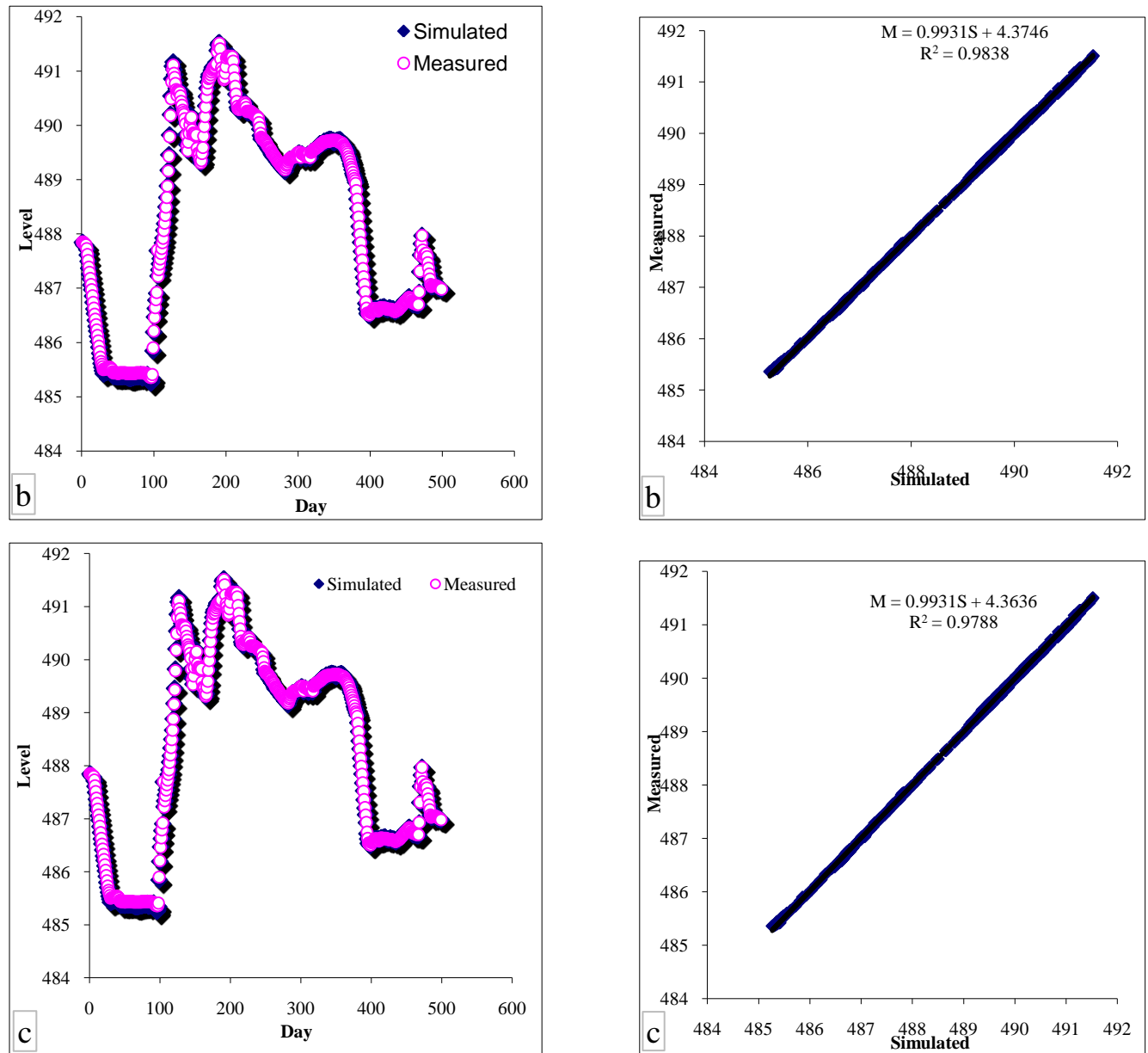

**Fig. 4:** Observed and simulated levels reservoirs of optimal ANN models during the validation period for: (a) 1-day ahead, (b) 2-day ahead, and (c) 3-day ahead predictions

*ANFIS models*

For a collection of entry-exit data like forecasting lake levels by the aid of the registered amount of reservoir level, we could apply different exploration methods of sugeno model. In this regard, recently studied results showed exploration type method does not have any influence on results [14-17]. Therefore, we have applied network partition for making neuro-fuzzy model in this study. When we specified the

best entering composition (ANN model) has been used for analyzing sensitivity influence of Mf types of entering variables. Table 3 shows different types of ANFIS MFs and Table 4 shows validation statistics of ANFIS models. Fig. 5 shows observed and simulated levels reservoirs of optimal ANFIS models during the validation period for 1-day, 2-day and 3-day ahead predictions.

**Table 3:** Different types of ANFIS MFs

Type of MFs	ANFIS structure	R <sup>2</sup>	RMSE(m)	MAE(m)
Triangular	3-3-1	0.981	0.066	0.042
Two Gaussian	3-6-1	0.976	0.093	0.052
Gaussian	3-6-1	0.989	0.053	0.028
Spherical	3-3-1	0.979	0.081	0.046

**Table 4:** Validation statistics of ANFIS models.

Model inputs	ANN structure (input-hidden-output)	R <sup>2</sup>	RMSE(m)	MAE(m)
<b>+1day prediction</b>				
L <sub>i</sub>	1-4-1	0.978	0.053	0.03
L <sub>i-1</sub> , L <sub>i</sub>	2-8-1	0.988	0.052	0.028
L <sub>i-2</sub> , L <sub>i-1</sub> , L <sub>i</sub>	3-9-1	0.991	0.048	0.024
<b>+2day prediction</b>				
L <sub>i</sub>	1-3-1	0.978	0.056	0.034
L <sub>i-1</sub> , L <sub>i</sub>	2-8-1	0.980	0.053	0.032
L <sub>i-2</sub> , L <sub>i-1</sub> , L <sub>i</sub>	3-4-1	0.983	0.049	0.023
<b>+3day prediction</b>				
L <sub>i</sub>	1-4-1	0.984	0.075	0.044
L <sub>i-1</sub> , L <sub>i</sub>	2-9-1	0.978	0.070	0.041
L <sub>i-2</sub> , L <sub>i-1</sub> , L <sub>i</sub>	3-4-1	0.980	0.065	0.039

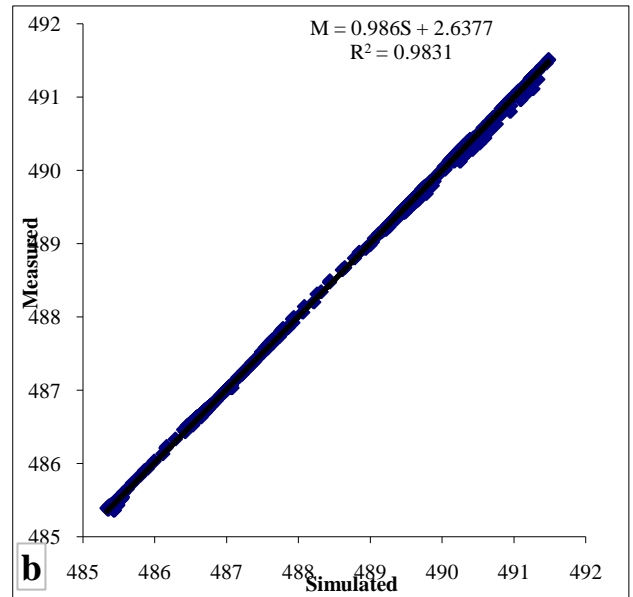
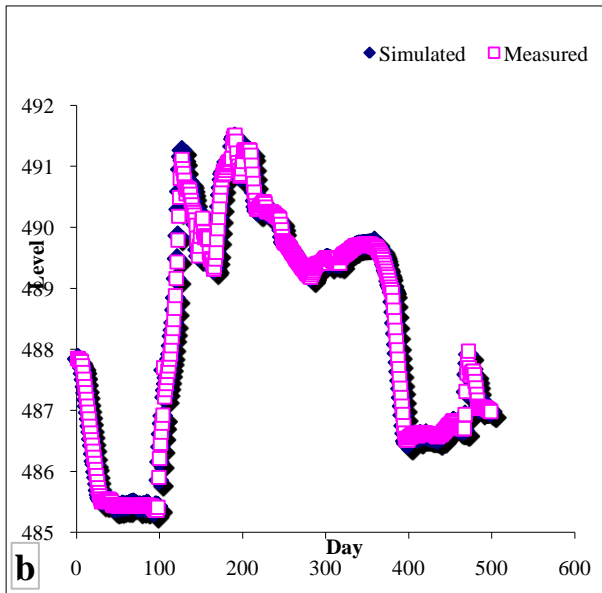
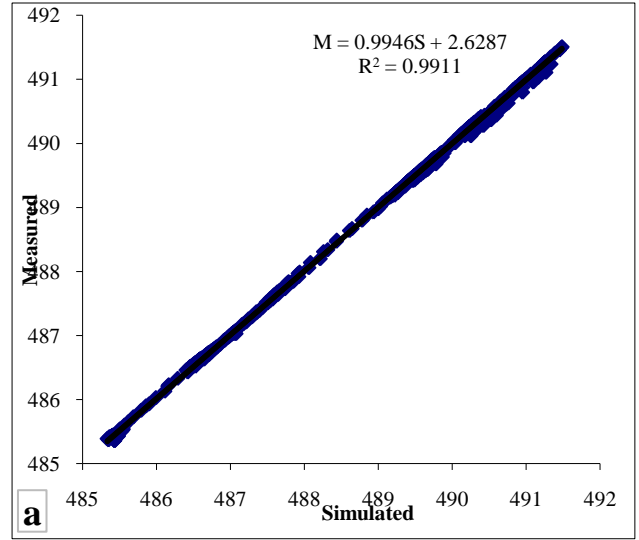
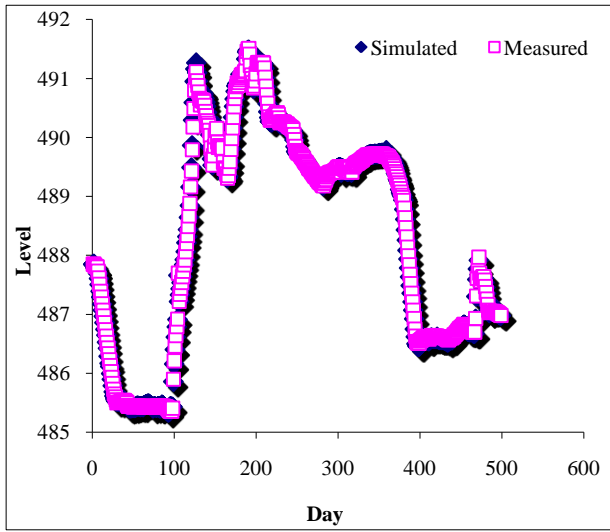

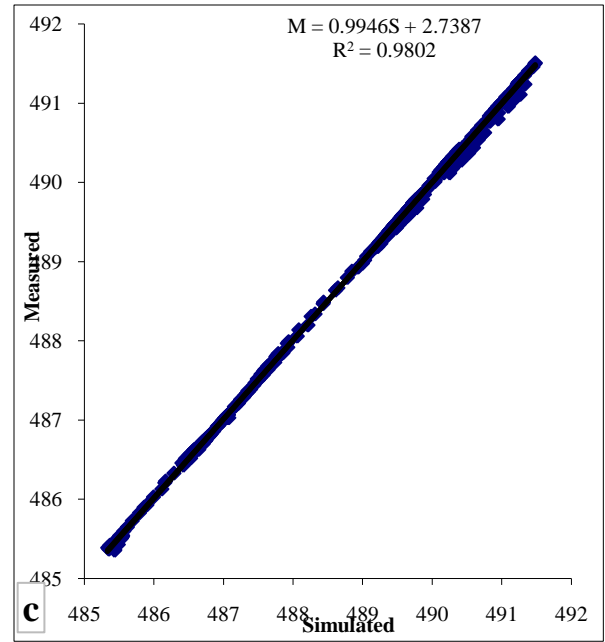
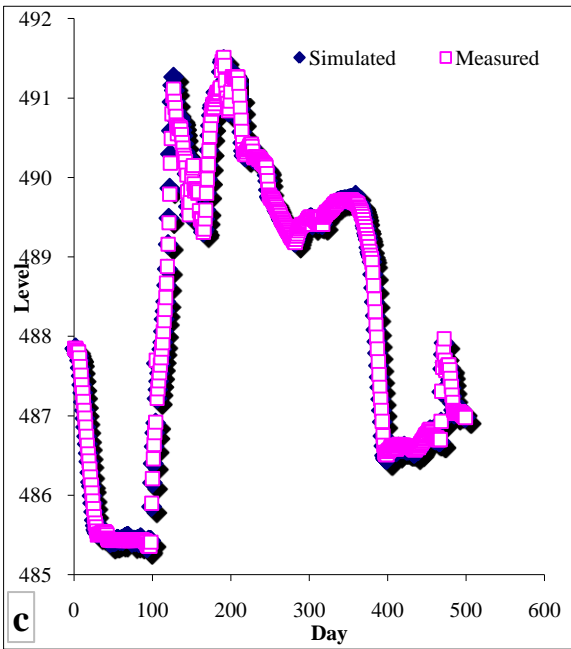

**Fig.5:** Observed and simulated levels reservoirs of optimal ANFIS models during the validation period for: (a) 1-day ahead, (b) 2-day ahead, and (c) 3-day ahead predictions

*Optimization of Cuckoo Optimization Algorithm (COA)*

The Meta-Heuristic algorithms are very sensitive for their parameters and the setting of the parameters can affect their efficiency. Parameters settings cause more reliability and flexibility of the algorithm. So, adjustments of the factors are one of the crucial steps in achieving the optimized solution in all

optimization problems. Table. 5 showed the selected parameters for COA algorithm. Fig. 6 shows Observed and simulated levels reservoirs of optimal ANN+COA models during the validation period for 1-day, 2-day and 3-day ahead. Table 6 shows validation statistics of ANN+COA models.

**Table 5:** Parameters settings for COA algorithm

Max number of eggs	Min number of eggs	Number of Initial population	Higher limitation of variable	Lower limitation of variable
14	3	40	6	-5
Population variance that cuts the optimization	Control parameter of egg laying (RadiusCoeff)	Max umber of cuckoos	Lambda variable (Motion Coeff)	Number of clusters
1e-13	4	20	14	1

**Table 6:** Validation statistics of ANN+COA models

Model inputs	R <sup>2</sup>	RMSE(m)	MAE(m)
<b>+1day prediction</b>			
L <sub>i</sub>	0.975	0.061	0.04
L <sub>i-1</sub> , L <sub>i</sub>	0.98	0.059	0.030
L <sub>i-2</sub> , L <sub>i-1</sub> , L <sub>i</sub>	0.98	0.055	0.025
<b>+2day prediction</b>			
L <sub>i</sub>	0.97	0.064	0.031
L <sub>i-1</sub> , L <sub>i</sub>	0.96	0.060	0.030
L <sub>i-2</sub> , L <sub>i-1</sub> , L <sub>i</sub>	0.96	0.060	0.027
<b>+3day prediction</b>			
L <sub>i</sub>	0.95	0.086	0.043
L <sub>i-1</sub> , L <sub>i</sub>	0.95	0.079	0.040
L <sub>i-2</sub> , L <sub>i-1</sub> , L <sub>i</sub>	0.94	0.071	0.038

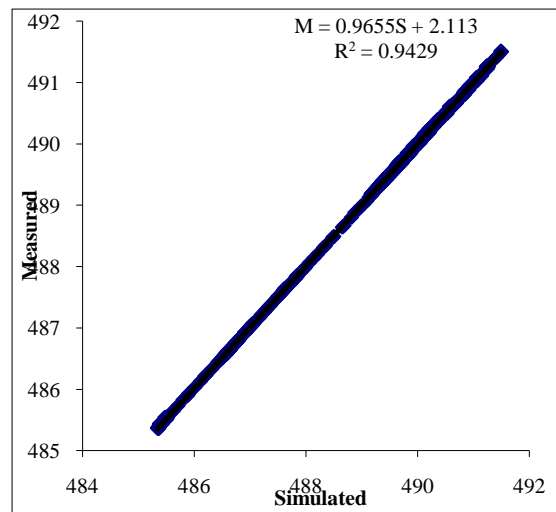
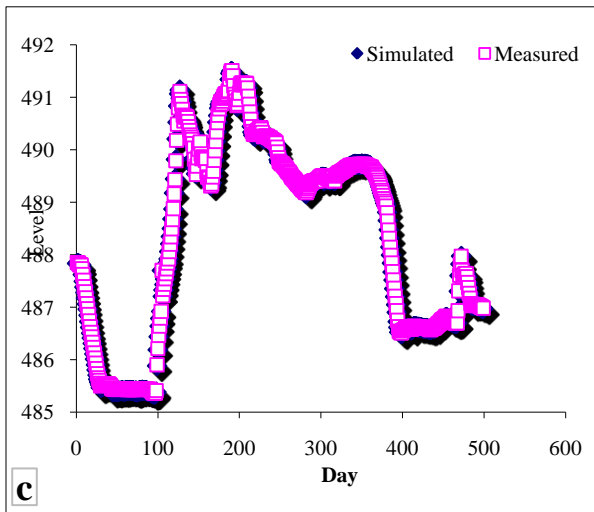
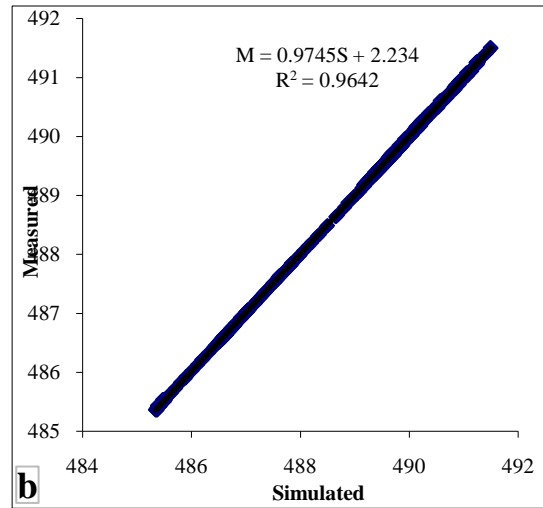
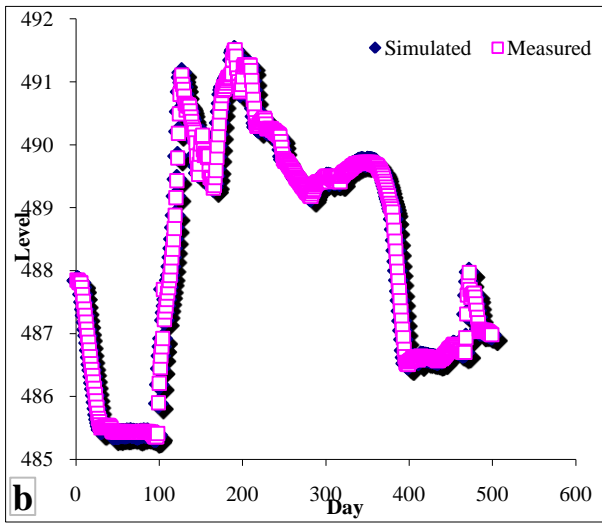
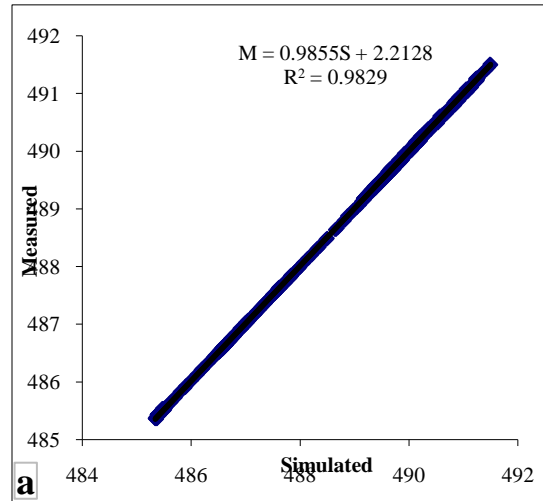
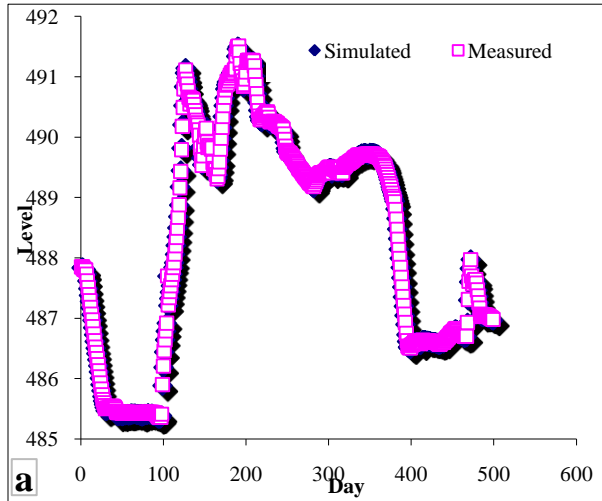

**Fig. 6:** Observed and simulated levels reservoirs of optimal ANN+COA models during the validation period for: (a) 1-day ahead and (b) 2-day ahead and 3-days ahead



## DISCUSSION

Normalizing data does have important role in improving performance, since number limit is different in different variables, before applying ANN model. We have approved it. if (z) was time series

and  $M = \max_i \{Z(t)\}$ ,  $Z_N(t)$  is normalize signal and would be indicated by

$$Z_N(t) = \frac{Z(t)}{M} \quad (6)$$

Table. 2 and Fig. 4 showed the result of evaluating nerve-network model forecasting for water level of reservoir in 1, 2, and 3 next days.

We have determined membership function limit and has listed in Table 3. Second column of the table shows the number of entering variables' MF. There is no rule for determining the number of MF in ANFIS model and should be selected by repeated procedure. It is clear, triangular MF, Gucci and Bell generalized are better than other MF. However, triangular membership function has provided the best result among all MF. The result of Russel and cambell [18] showed application of MF. Any ANFIS model (Gucci membership function application) test statistic has been provided in the Table. 4. Fig. 4 has shown the observed level and reservoir simulated (by the aid of ANFIS model three entries) in the test duration. ANFIS model has provided three entries like ANN models and the best result among other composition. Also, increasing time interval leads to decrease models precision. Comparison between Tables 2 and 4 showed ANFIS models are better than ANN, but the difference among the two methods is not high.

Recently, applying artificial intelligence as feasible instrument for modeling complicated nonlinear phenomenon has been accepted and developed. In this regard, the method of artificial nervous network and neuro phase inference system has been applied broadly. In recent studies, we have used of Artificial Neutral Network (ANN) capabilities in modeling water resource variables [19].

Jain and *et al.* [20] have used of ANN for forecasting inner pouring of the water reservoir and its performance. More and Deo [21] has used of ANN for forecasting wind. Makarynska and Makarynsky [22] has used of ANN for forecasting hourly changes in sea level by error times of 1-5 days. Cimon and Kisi [23] have used of ANN, AVM for modeling lake level fluctuations.

ANFIS is composed of comparatively nervous system and phase inference system. Phase inference system is determined by learning NN algorithm. Because this system is based on phase system inference has reflected outstanding knowledge and one important aspect is to interpret by if-then rule.

ANFIS could estimate any function on compressed complex by any exactness degree [24].

## CONCLUSION

The potential of the three different methods, ANN, ANFIS and ANN+COA has been investigated in this paper for estimation of reservoir level using climatic variables. The daily climatic data, air temperature, sunshine, humidity and wind speed, from Chahnimeh Zabol station, in Iran were applied as inputs to these models. Forecasting reservoir fluctuation level is very important in designing and making the sea beach structure and reservoir, industrial operation and also managing water reservoir integration. In this study, semi-well reservoir level observation for education and testing ANN, ANFIS models have been used. ANN, ANFIS and ANN+COA models has been used for daily forecasting of reservoir level in three-time series. This has created qualified forecasting in the all-time series. Provided result has shown models capability in educating nonlinear behavior of reservoir level changes in RMSE, R2, MAE. Results showed that neuro-fuzzy superiority on nerve network models and in general forecasting for the two models was good. Its cause is good quality and high auto-correlation in reservoir level data.

## ETHICAL ISSUES

Ethical issues such as plagiarism have been observed by the authors.

## CONFLICT OF INTEREST

There was no conflict of interest.

## AUTHORS CONTRIBUTIONS

All authors contributed equally.

## FUNDING/SUPPRTING

This study had no financial support and supported by the authors.

## REFERENCES

- [1] Bae DH, Jeong DM, Kim G. Monthly dam inflow forecasts using weather forecast information and neuro-fuzzy technique. *HYDROLOG SCI J.* 2007; 52 (1): 99–13.
- [2] Berrazouane S, Mohammadi K. Parameter optimization via cuckoo optimization algorithm of fuzzy controller for energy management of a hybrid power system, *ENERG CONVERS MANAGE.* 2014; 78(1): 652–60.
- [3] Chang, FJ, Chang, YT. Adaptive neuro-fuzzy inference system for prediction of water level in

- reservoir. *ADV WATER RESOUR.* 2006; 29(1): 1–10.
- [4] Chang FJ, Chen YC. Counter propagation fuzzy-neural network modeling approach to real time stream flow prediction. *J HYDROL.* 2001; 245 (1-4): 153–64.
- [5] Shiri J, Makarynskyy O, Kisi O, Dierickx W, Fakheri Fard A. Prediction of short term operational water levels using an adaptive neuro-fuzzy inference system. *J. Waterw. Port Coast. Ocean Eng.* 2011; 137(6): 344-54.
- [6] Hong YST, White PA. Hydrological modeling using a dynamic neuro- fuzzy system with on-line and local learning algorithm. *ADV WATER RESOUR.* 2009; 32(1): 110–19.
- [7] Kazeminezhad MH, Etemad-shahidi A, Mousavi SJ. Application of fuzzy inference system in the prediction of wave parameters. *OCEAN ENG.* 2005; 32(14-15): 1709–25.
- [8] Keskin ME, Terzi O, Taylan D. Fuzzy logic model approaches to daily pan evaporation estimation in Western Turkey. *HYDROLOG SCI J.* 2004; 49 (6):1001–10.
- [9] Moghaddamnia A, Ghafari Gousheh M, Piri J, Amin S, Han D. Evaporation estimation using artificial neural networks and adaptive neuro-fuzzy inference system techniques. *Adv. Water Resour.* 2009; 32(1): 88–97.
- [10] Yang XS, Deb S. Multiobjective cuckoo search for design optimization, *Comput Oper Res.* 2013; 40(6):1616–24.
- [11] Kisi O, Ozturk O. Adaptive neurofuzzy computing technique for evaporation transpiration estimation. *J IRRIG DRAIN E-ASCE.* 2007; 133 (4): 368–79.
- [12] Kisi O, Shiri J, Nikoofar B. Forecasting daily lake levels using artificial intelligence approaches. *Computers & Geosciences.* 2012; 41 (1): 169-80.
- [13] Jain SK, Das D, Srivastava DK. Application of ANN for reservoir inflow prediction and operation. *J WATER RES PL-ASCE.* 1999; 125(5): 263–71.
- [14] Mamdani EH, Assilian S. An experiment in linguistic synthesis with a fuzzy logic controller. *INT J MACH TOOL MANU.* 1975; 7 (1): 1–13.
- [15] Rajabioun R. Cuckoo Optimization Algorithm. *Appl Soft Comput.* 2011; 11(8): 5508 – 18.
- [16] More A, Deo MC. Forecasting wind with neural networks. *Marine Structures.* 2003; 16(1): 35–49.
- [17] Ondimu S, Murase H, Reservoir level forecasting using neural networks: Lake Naivasha *Biosyst Eng.* 2007; 96 (1): 135–38.
- [18] Russell SO, Campbell PF. Reservoir operating rules with fuzzy programming. *J. Water Resour Plann Manage.* 1996; 122 (3):165–70.
- [19] Ozger M, Yildirim G. Determining turbulent flow friction coefficient using adaptive neuro-fuzzy computing technique. *Adv Eng Software* 2009; 40(4): 281–87.
- [20] Piri J, Amin S, Moghaddamnia A, Han D, Remesun D. Daily pan evaporation modeling is hot and dry climate. 2009; *J Hydrol Eng.* 14(8): 803-811.
- [21] More A, Deo MC. Forecasting wind with neural networks. *Marine Structures.* 2003; 16(1), 35–49
- [22] Makarynskyy O, Makarynska D, Kuhn M, Featherstone WE. Predicting sea level variations with artificial neural networks at Hillarys Harbour, Western Australia. *ESTUAR COAST SHELF S.* 2004; 61(2): 351–60.
- [23] Cimon M, Kisi O. Comparison of two different data-driven techniques in modeling lake level fluctuations in Turkey. *J HYDROL.* 2009; 378 (3-4): 253–62.
- [24] Takagi T., Sugeno M. Fuzzy identification of systems and its application to modeling and control. *IEEE Trans Syst Man Cybern B.* 1985; 15 (1): 116–32.